



## TRENNI / SHUTTLE TRAINS

## NAVETTE / SHUTTLE BUSES

## APERTURA IMPIANTI / LIFTS OPENINGS

### CANAZEI - CAMPITELLO - CANAZEI 22.06. - 15.09.2024

Canazei Piazz Marconi	09:30 11:15 16:00 18:00
Campitello Piazz de Ciampedel	10:00 11:45 16:20 18:20
Parco Ischia - Ischia Playground	10:10 11:45 16:30 18:30
Canazei Piazz Marconi	10:30 12:00 17:00 19:00

### CANAZEI - ALBA - PENIA - CANAZEI 22.06. - 15.09.2024

Canazei Piazz Marconi	10:30 12:00 15:00 17:00
Parco giochi Alba - Alba Playground	10:40 12:10 15:15 17:15
Parco Ischia - Ischia Sawmill	10:50 - 15:30 17:30
Penia Segheria - Penia Sawmill	11:00 12:25 15:40 17:40
Canazei Piazz Marconi	11:15 12:00 16:00 18:00

**PREZZI / PRICES:**  
 Corsa solo Andata / One-way: € 3  
 Andata e Ritorno singola corsa / Round-trip ticket single tour: € 5,50  
 Con Val di Fassa Guest Card / with Val di Fassa Guest Card: € 5

**Andata e Ritorno giro completo / Round-trip ticket complete tour:** € 10  
 Con / with Val di Fassa Guest Card / with Val di Fassa Guest Card: € 9  
 Bambini fino a 9/9 cm / Children up to 9/9 cm tall: gratuito / for free  
 Info: +39 335 1439931

### POZZA DI FASSA - VAL SAN NICOLÒ E RITORNO / AND BACK 15.06. - 22.09.2024

Andata / One-way	08:45 09:30 10:30 11:30 12:30 14:30 15:30 16:30
Malga Crocifisso	08:55 09:40 10:40 11:40 12:40 14:40 15:40 16:40
Baita Ciampie	09:05 09:50 10:50 11:50 12:50 14:50 15:50 16:50

### PREZZI / PRICES:

Corsa singola / single run: € 8,50  
 Con / with Val di Fassa Guest Card: € 6,50  
 Andata e ritorno / return ticket: € 17  
 Con / with Val di Fassa Guest Card: € 13  
 Bambini 0-6 anni / Children 0-6 years: gratuito / for free (rapporto / ratio 1:1)  
 Cani (con guinzaglio e museruola) / Dogs (with muzzle and leash): € 2  
 Info: +39 335 2952124  
 Prenotazioni per gruppi / Reservations for groups (min 10 pax): +39 335 786544

### MOENA | 1 - Piazz de Ramon - Sameda 09.06. - 15.09.2024

Piazz de Ramon (partenza per Sameda/departure to Sameda)	09:10 10:20 11:40 12:45 15:40 16:50 18:00 19:10 21:10 22:20
Strada de Salgè (bivio per Sameda di fronte Hotel Valchehiera / crossroad to Sameda, in front of Hotel Valchehiera)	09:13 10:23 11:43 12:48 15:43 16:53 18:03 19:13 21:13 22:23
Troi de Costa (Sameda)	09:16 10:26 11:46 12:51 15:46 16:56 18:06 19:16 21:16 22:26
Strada de Pecè (piazzale Lago Pecè - rotatoria nord / road lake - roundabout nord)	09:23 10:33 11:53 12:58 15:53 17:03 18:13 19:23 21:23 22:33
Piazz de Ramon	09:35 10:45 12:05 13:10 16:05 17:15 18:25 19:35 21:35 22:45

### MOENA | 2 - Piazz de Ramon - Sorte / Rancolin 09.06. - 15.09.2024

Piazz de Ramon (per / to Rancolin-Even)	09:45 11:05 12:15 16:15 17:25 18:35 19:45 21:45 22:55
Strada Sastionch (Hotel Ciampian)	09:48 11:08 12:18 16:18 17:28 18:38 19:48 21:48 22:58
Strada de Sort (bivio Biencia)	09:52 11:12 12:22 16:22 17:32 18:42 19:52 21:52 23:02
Strada de Massort (parco giochi Prato di Sorte playground)	09:55 11:15 12:25 16:25 17:35 18:45 19:55 21:55 23:05
Strada de Prealon (Supermarket Trentini Coop)	10:00 11:20 12:30 16:30 17:40 18:50 20:00 22:00 23:10
Piazz de Ramon	10:10 11:30 12:40 16:40 17:50 19:00 20:10 22:10 23:20

**PREZZI / PRICES:**  
 Bambini fino a 3 anni / Children up to 3 years: gratuito / for free  
 Bambini oltre 3 anni e adulti / Children over 3 and adults: € 2

Info: +39 349 6796211 / info@miotrain.it

### VAL DUROIN - CAMPITELLO 15.06. - 15.09.2024

**TRAGITTO / RIDE:**  
 da Campitello Strada de Salin al rifugio Micheluzzi / from Campitello Strada de Salin to the Rifugio Micheluzzi hut.

**ORARIO / TIMETABLE:**  
 7:00 - 19:00  
 (con cadenza ogni 30 minuti / every 30 minutes)

### PREZZI / PRICES:

Da / from	A / to	Andata One-way	Ritorno Back	Andata e Ritorno / Return Ticket
Campitello Strada de Salin	Rifugio Micheluzzi	€ 10	€ 10	€ 20

**Bambini (fino a 10 anni / Children up to 10 years)**

Campitello Rifugio Micheluzzi € 5 € 5 € 10

POSSessori CON VAL DI FASSA GUEST CARD / WAL DI FASSA GUEST CARD OWNERS

Campitello Rifugio Micheluzzi € 8 € 8 € 16

**Bambini (fino a 10 anni / Children up to 10 years)**

Campitello Rifugio Micheluzzi € 4 € 4 € 8

Canì: € 2/5 (a seconda della taglia / depending on the size)

Transporto biciclette / bike transportation: € 5

### VAL CONTRIN (Baita Locia) - ALBA DI CANAZEI 07.06. - 11.09.2024

**TRAGITTO / RIDE:**  
 dal parcheggio della cabinovia Ciampac Imbocco del sentiero nr. 602 al rifugio Baita Locia de Contrin / from the parking of the Ciampac lift (beginning of the path nr. 602) to the Baita Locia de Contrin hut.

**ORARIO / TIMETABLE:**  
 07:30 - 11:00  
 dalle 16:00 in poi / from 4:00 p.m. onwards  
 (per il ritorno contattare il taxi / for the return journey call the taxi)

### PREZZI / PRICES:

Da / from	A / to	Da 1 a 4 persone / from 1 to 4 people	da 5 persone / from 5 people
Alba di Canazei	Baita Locia Contrin	€ 3	€ 8

Prenotazione obbligatoria entro il giorno precedente ai numeri / Reservation required within the previous day at:

Taxi Iorini: +39 337 458742 / +39 336 808404  
 Wolf's Wagen: +39 347 2931991



### CASSA PANORAMA PASS / PANORAMA PASS TICKET PICK UP BOX IMPIANTO NON INCLUSO NEL PANORAMA PASS OFFICE NOT INCLUDED IN THE PANORAMA PASS

101	Canazei - Pecol	15.04. 29.09.
102	Pecol - Col dei Rossi	15.04. 29.09.
103	Pecol - Soss Pordoi	17.05. 03.11.
104	Pian Prataces - Gherdecia	29.06. 15.09.
105	Fodom (Vaz - Pordoi)	15.06. 22.09.
130	Alba - Col dei Rossi	08.06. 06.10.
131	Alba - Ciampac	15.06. 15.09.
136	Rosell - Giuella	15.06. 15.09.
141	Malga - Sauro	29.06. 15.09.
43	Serauta - Punta Rocca	29.06. 15.09.
13	Padon 2	22.06. 15.09.
141	Campitello - Col Rodella	08.06. 06.10.
152	Rodella - Des Alpes	29.06. 15.09.
155	Pradell - Des Alpes	29.06. 15.09.
56	Forcella Sassolungo	20.06. 10.10.
201	Bufaure - Bufaure	15.06. 22.09.
206	Bufaure - Col Valvacin	15.06. 22.09.
211	Vigo - Ciampiede	01.06. 06.10.
215	Pian Peci - Ciampiede	15.06. 15.09.
217	Vajolet 1	15.06. 15.09.
218	Vajolet 2	15.06. 15.09.
223	Pian Peci - Pra Martin	29.06. 01.09.
400	Tires	18.05. 03.11.
401	Nova Levante	18.05. 03.11.
402	König Laurin 1	30.05. 03.11.
403	König Laurin 2	30.05. 03.11.
404	Tscheln	30.05. 13.10.
411	Carezza - Paolina	30.05. 13.10.
201	Ronchi - Valbona	15.06. 22.09.
202	Valbona - Le Cune	15.06. 22.09.
205	Campo - Le Cune	13.07. 01.09.
303	Costabella	22.06. 15.09.
309	Col Margherita	29.06. 15.09.
407	Le Buse - Larseel	06.07. 08.09.
408	Falcaide - Le Buse	06.07. 08.09.
4045	Castelir - Le Fassane - La Morea	15.06. 22.09.

Tutti gli orari e i prezzi degli impianti di risalita sono disponibili su: All the timetables and prices of the lifts are available on: [fassa.com](http://fassa.com)



## CON LA VAL DI FASSA GUEST CARD VIAGGI GRATUITAMENTE SU TUTTI I MEZZI DI TRENTINO TRASPORTI

## THANKS TO THE VAL DI FASSA GUEST CARD YOU TRAVEL FOR FREE ON ALL TRENTINO TRASPORTI BUSES



Chiedi la card gratuita al tuo datore di alloggio, partner dell'Azienda per il Turismo della Val di Fassa, e attivata sull'app Mio Trentino.

Ask for your free card to your host, partner of Val di Fassa Tourist Board, and activate it on the app Mio Trentino.

## PANORAMA PASS 01.06. - 06.10.2024

Panorama Pass è una tessera di libero ed illimitato accesso agli impianti di risalita, acquistabile online su [shop.dolomitisuperski.com](http://shop.dolomitisuperski.com), presso le cascate abilitate degli impianti di risalita e negli uffici turistici.

Panorama Pass è una card that gives right to an unlimited and free access to the lifts open in summer: you can purchase it online at [shop.dolomitisuperski.com](http://shop.dolomitisuperski.com), at the cash desks of authorised lifts and at the tourist offices.

### PREZZI / PRICES:

<b>3 GIORNI SU 6 3 DAYS OUT OF 6</b>	<b>4 GIORNI SU 6 4 DAYS OUT OF 6</b>	<b>7 GIORNI SU 13 7 DAYS OUT OF 13</b>
Adulti / Adults € 85 (con / with Val di Fassa Guest Card: € 77)	Adulti / Adults € 120 (con / with Val di Fassa Guest Card: € 108)	Adulti / Adults € 141 (con / with Val di Fassa Guest Card: € 127)

**Junior / Juniors** (invalide dopo / born after 01.01.2008) € 49 (con / with Val di Fassa Guest Card: € 44)  
**Junior / Juniors** (invalide dopo / born after 01.01.2008) € 77 (con / with Val di Fassa Guest Card: € 69)  
**Junior / Juniors** (invalide dopo / born after 01.01.2008) € 80 (con / with Val di Fassa Guest Card: € 80)

I bambini nati dopo il 01.01.2016 viaggiano gratis (rapporto 1:1) / Children born after 01.01.2016 travel for free (ratio 1:1)

**PROMO FAMIGLIA 2024:** nel caso di acquisto combinato e contestuale di 2 Panorama Pass adulti (genitori o adulti accompagnatori) e 2 Panorama Pass junior (nati dopo il 01.01.2008), il pass per il secondo junior è in omaggio. La promozione vale per multipli di 2 junior, fino ad un massimo di tre gratuiti junior. Non vale per gruppi organizzati.

**FAMILY PROMOTION SUMMER 2024:** purchasing simultaneously 2 adults Panorama Pass tickets (parents or accompanying adults) together with 2 junior Panorama Pass tickets (born after 01.01.2008), you get the second junior ticket for free. The promotion is valid for multiple of 2 juniors, up to a maximum number of 3 junior tickets. Not valid for organized groups.



## LEGENDA / KEY

- TT TRENTINO TRASPORTI
- AAM ALTOADIGIEMOBILITÀ
- DB DOLOMITI BUS
- TSG TRASPORTO COMUNE S. GIOVANNI S. GIOVANNI MUNICIPALITY TRANSPORT
- N NAVETTA SHUTTLE BUS
- TR TRENTINO SHUTTLE TRAIN
- T TAXI
- B-E BIKE EXPRESS
- STAZIONE RICARICA E-BIKE E-BIKE CHARGING STATION

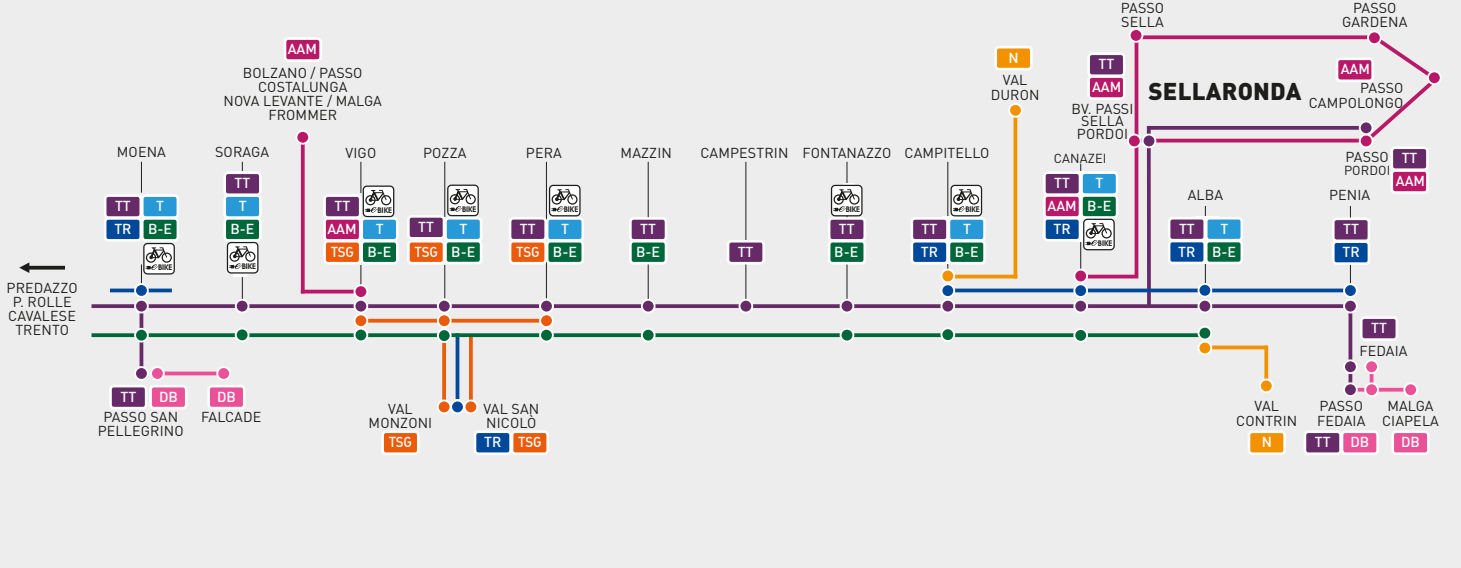

## NOLEGGI BIKE / BIKE RENTALS

<b>MOENA</b> MOENA DOLOMITI Strada de San Pelerem, 2 tel. +39 0462 573770 info@scuolasciomoena.it scuolasciomoena.it	<b>SAN GIOVANNI DI FASSA</b> FASSA RENT Strada de Meida, 106 - Pozza tel. +39 0462 775177 info@fassarent.it fassarent.it	<b>CANAZEI</b> 6PUNTO9 Strada Dolomites, 72 tel. +39 0462 600232 tel. +39 0462 8036047 info@6punto9.com 6punto9.com
<b>SPORT NAVALGE</b> Piazz de Navalgè, 5 tel. +39 0462 573050 info@sportnavalgè.it sportnavalgè.it	<b>GROSS SPORT</b> Str. Madona de LAiut, 2 - Pozza tel. +39 0462 743373 tel. +39 338 9547208 info@grossport.it grossport.it	<b>DETOMAS SHOP</b> Strada de Parèda, 31 tel. +39 0462 602247 tel. +39 338 9547208 info@detomasshop.com detomasshop.com
<b>SORAGA DI FASSA</b>	<b>CECE SPORT BRUNEL</b> Piazza Cioch, 28 tel. +39 0462 768363 snoccece@yahoo.it	<b>NORTHLAND</b> Strada de Meida, 148 - Pozza tel. +39 0462 775060 info@northlandski.com webike.rent
<b>SKI E BIKE GIULIANI</b> Siraclon de Faccia, 5 tel. +39 0462 758011 tel. +39 340 0543788 noleggi@skiandbike.com skibikegiuliani.com	<b>CAMPESTRIN</b> FASSA SKI BIKE Strada Anfermoa, 8 tel. +39 0462 3460374 info@fassaskibike.com fassaskibike.com	<b>PEAK SPORT ADVENTURE</b> Strada de Parèda, 83 tel. +39 0462 600247 tel. +39 338 1444711 info@peaksport.it canazeibike.com
<b>SAN GIOVANNI DI FASSA</b> TONY SPORT Strada Resza, 11 - Vigo tel. +39 0462 763275 info@tonysport.it tonysport.it	<b>CAMPITELLO DI FASSA</b> FASSA SKI BIKE Strada de Peni de Sara, 10 tel. +39 0462 750145 tel. +39 338 3460374 info@fassaskibike.com fassaskibike.com	<b>SKI PAOLO NOLEGGIO SPORT</b> Strada de Contrin, 18 - Alba tel. +39 0462 600347 info@skipaolo.it skipaolo.it
<b>SPORT LUCY</b> Passo Costalunga, 5 - Vigo tel. +39 0471 612162 sport@tin.it sportlucy.it		

## FASSA & FEMME BIKE EXPRESS

### AUTOBUS DI RIENTRO LUNGO LA PISTA CICLOPEDONALE BUS SERVICE TO COME BACK ALONG THE CYCLING ROUTE

04.05. - 09.06.2024 / 21.09. - 13.10.2024  
 Sabato e domenica / Saturday and Sunday  
 10.06. - 15.09.2024  
 Tutti i giorni / Every day

MOLINA DI FEMME - BUS STOP PARCHEGGIO VIA SEGHERIE VIA SEGHERIE PARKING AREA	08:30	13:00	16:35
STAZIONE FONDOVALLE CABINOVIA CERMIS CERMIS CABIN LIFT VALLEY STATION	08:36	13:06	16:41
LAGO DI TESSERO - CENTRO DEL FONDO SOLO SU RICHIESTA / ONLY ON REQUEST	08:47	13:17	16:52
ZIANO - BUS STOP VIA STAZIONE c/o LA SPORTIVA FACTORY SHOP	08:55	13:25	17:00
PREDAZZO - CABINOVIA LATEMAR 2200 LATEMAR 2200 CABIN LIFT	09:05	13:35	17:10
FORNO - PASTICCERIA REINHARDT / BUS STOP	09:13	13:43	17:18
MOENA - BICI GRILL	09:25	13:50	17:25
SORAGA DI FASSA - BUS STOP CAMPO SPORTIVO SPORTSGROUND	09:30	14:00	17:35
VIGO DI FASSA - HOTEL CARPE DIEM BUS STOP SOLO SU RICHIESTA / ONLY ON REQUEST	-	-	17:40
POZZA DI FASSA - PLESSO SCOLASTICO / SCHOOL BUS STOP	09:36	14:06	17:46
PERA DI FASSA - SEGGOVIA VAJOLET / VAJOLET CHAIR LIFT	09:41	14:11	17:51
MAZZIN - BUS STOP	09:45	14:15	17:55
FONTANAZZO - ZONA ARTIGIANALE / CYCLING ROUTE START	09:50	14:20	18:00
CAMPITELLO DI FASSA - CASERMA W.F.F. / FIRE DEPARTMENT	09:55	14:25	18:05
GANAZI - IMPIANTI BELVEDERE / BELVEDERE CABIN LIFT	10:05	14:35	18:15
ALBA DI CANAZEI - IMPIANTI CIAMPAC / CIAMPAC CABIN LIFT	10:15	14:45	18:25

ci dal / from 10:06. al / to 15:09.2024

**BIGLIETTO GIORNALIERO DAILY TICKET**  
 Adulti / adults: € 14  
 € 8 con / with VAL DI FASSA / FEMME CEMBRA GUEST CARD  
 Bambini fino a 12 anni / Children up to 12 years: € 7  
 € 4 con / with VAL DI FASSA / FEMME CEMBRA GUEST CARD  
 Supplemento carrello / Trailer extra charge: € 5  
 € 4 con / with VAL DI FASSA / FEMME CEMBRA GUEST CARD  
 Trasporto bici incluso nel prezzo / bike transport included in price

**PRENOTAZIONE CONSIGLIATA / RESERVATION RECOMMENDED.**  
 fino a 30 minuti prima della corsa su: available up to 30 min. before the bus departure on: [ctago.it](http://ctago.it)



## SERVIZIO DI TRASPORTO PUBBLICO SAN GIOVANNI DI FASSA / PUBLIC TRANSPORT SAN GIOVANNI DI FASSA

### POZZA - PERA - VIGO | TRASPORTO INTERNO SAN GIOVANNI DI FASSA / SAN GIOVANNI DI FASSA MUNICIPALITY TRANSPORT 01.06. - 06.10.2024

Poza, VIDOR START	08:00 09:00 09:20 10:00 10:20 11:00 11:20 12:00 13:20 14:20 15:00 15:20 - 16:20 17:00 17:20 18:00
Poza, PONT DE FAVÉ - BUFFAURE LIFTS → POZZA	08:02 09:02 09:22 10:02 10:22 11:02 11:22 12:02 13:22 14:22 15:02 15:22 - 16:22 17:02 17:22 18:02
Poza, PIAZZA DE SÉN NICOLIU - DA MICHELIA	08:03 09:03 09:23 10:03 10:23 11:03 11:23 12:03 13:23 14:23 15:03 15:23 - 16:23 17:03 17:23 18:03
Poza, PIAZZA D. DE DOLOMIEU - FARMACIA	08:04 09:04 09:24 10:04 10:24 11:04 11:24 12:04 13:24 14:24 15:04 15:24 - 16:24 17:04 17:24 -
Poza, COL DE ZECOL - BAR AL PONTE	08:05 09:05 09:25 10:05 10:25 11:05 11:25 12:05 13:25 14:25 15:05 15:25 - 16:25 17:05 17:25 18:05
Poza, PRA - ZIRM	08:07 09:07 09:27 10:07 10:27 11:07 11:27 12:07 13:27 14:27 15:07 15:27 - 16:27 17:07 17:27 18:07
Poza, TROI DE VICH - HOTEL TOURING	08:10 09:10 - 10:10 - 11:10 - 12:10 - - 15:10 - - 17:10 -





DOLOMITES

**POZZA DI FASSA – VAL SAN NICOLÒ**  
Loc. Vidor – loc. Saùch



01.06 – 06.10

ORARIO / TIMETABLE / FAHRPLAN (corse ogni 30 minuti / rides every 30 minutes / Fahrten alle 30 Minuten):

01.06 – 29.06 / 08.09 – 06.10: 8.30-12.30 / 14.00-18.00

ultima salita mattino / last morning uphill ride / letzter bergauf Fahrt Morgens: 12.15

prima salita pomeriggio / first afternoon uphill ride / erster bergauf Fahrt Nachmittags: 13.45

ultima salita pomeriggio / last afternoon uphill ride / letzter bergauf Fahrt Nachmittags: 17.45

30.06 – 07.09:

8.30-18.30

ultima salita pomeriggio / last afternoon uphill ride / letzter bergauf Fahrt Nachmittags: 18.15

PREZZI / FARES / PREISE:

Corsa singola / one way / Einzelfahrt: € 6,50

con / with / mit Val di Fassa Guest Card: € 4,50 \*

Bambini / children / Kinder (fino a 6 anni / up to 6 years / bis 6 Jahre): GRATIS 1:1

Cani / dogs / Hunde: € 2 (guinzaglio e museruola / muzzle and leash / Leine und Maulkorb)

\* Sconto Val di Fassa Guest Card solo con prenotazione online sul sito [www.ctago.it](http://www.ctago.it)

\* Val di Fassa Guest Card discount only with online booking on the site [www.ctago.it](http://www.ctago.it)

\* Val di Fassa Guest Card Ermäßigung nur bei Online-Buchung auf der Website [www.ctago.it](http://www.ctago.it)

INFO:

tel. +39 335 6454755

**POZZA DI FASSA – VAL MONZONI**  
Loc. Vidor – Malga Monzoni



08.06 – 22.09

ORARIO / TIMETABLE / FAHRPLAN (corse ogni 30 minuti / rides every 30 minutes / Fahrten alle 30 Minuten):

08.06 – 29.06 / 08.09 – 22.09: 8.30-12.15 / 14.00-17.00

ultima salita mattino / last morning uphill ride / letzter bergauf Fahrt Morgens: 12.00

prima salita pomeriggio / first afternoon uphill ride / erster bergauf Fahrt Nachmittags: 13.45

ultima salita pomeriggio / last afternoon uphill ride / letzter bergauf Fahrt Nachmittags: 16.45

30.06 – 07.09:

8.30-18.00

ultima salita pomeriggio / last afternoon uphill ride / letzter bergauf Fahrt Nachmittags: 17.45

PREZZI / FARES / PREISE:

Corsa singola / one way / Einzelfahrt: € 6,50

con / with / mit Val di Fassa Guest Card: € 4,50 \*

Bambini / children / Kinder (fino a 6 anni / up to 6 years / bis 6 Jahre): GRATIS 1:1

Cani / dogs / Hunde: € 2 (guinzaglio e museruola / muzzle and leash / Leine und Maulkorb)

\* Sconto Val di Fassa Guest Card solo con prenotazione online sul sito [www.ctago.it](http://www.ctago.it)

\* Val di Fassa Guest Card discount only with online booking on the site [www.ctago.it](http://www.ctago.it)

\* Val di Fassa Guest Card Ermäßigung nur bei Online-Buchung auf der Website [www.ctago.it](http://www.ctago.it)

INFO:

tel. +39 335 7865464

# TRASPORTO INTERNO COMUNE DI SAN GIOVANNI DI FASSA SAN GIOVANNI DI FASSA MUNICIPALITY TRANSPORT BUSLINIE DER GEMEINDE SAN GIOVANNI DI FASSA

01.06.2024 - 06.10.2024

**POZZA - VIGO - TAMION - PERA | LINEA ROSSA / RED LINE / ROTE LINIE | 01.06. - 06.10.2024**

**POZZA - VIGO - PERA - MUNCION | LINEA ARANCIONE / ORANGE LINE / ORANGE LINIE | 01.06. - 06.10.2024**

**POZZA - VIGO - PERA | LINEA VERDE / GREEN LINE / GRÜNE LINIE | 30.06. - 07.09.2024**

Poza, VIDOR START	8:00	9:00	9:20	10:00	10:20	11:00	11:20	12:00	13:20	14:20	15:00	15:20	-	16:20	17:00	17:20	18:00
Poza, PONT DE FAVÉ - BUFFAURE LIFTS → POZA	8:02	9:02	9:22	10:02	10:22	11:02	11:22	12:02	13:22	14:22	15:02	15:22	-	16:22	17:02	17:22	18:02
Poza, PIAZA DE SÈN NICOLÒ - DA MICHELE	8:03	9:03	9:23	10:03	10:23	11:03	11:23	12:03	13:23	14:23	15:03	15:23	-	16:23	17:03	17:23	18:03
Poza, PIAZA D. DE DOLOMIEU - FARMACIA	8:04	9:04	9:24	10:04	10:24	11:04	11:24	12:04	13:24	14:24	15:04	15:24	-	16:24	17:04	17:24	-
Poza, COL DE ZECOL - BAR AL PONTE	8:05	9:05	9:25	10:05	10:25	11:05	11:25	12:05	13:25	14:25	15:05	15:25	-	16:25	17:05	17:25	18:05
Poza, PRA - ZIRM	8:07	9:07	9:27	10:07	10:27	11:07	11:27	12:07	13:27	14:27	15:07	15:27	-	16:27	17:07	17:27	18:07
Poza, TROI DE VICH - HOTEL TOURING	8:10	9:10	-	10:10	-	11:10	-	12:10	-	-	15:10	-	-	-	17:10	-	18:10
Poza, FASSA COOP → VICH	8:11	9:11	-	10:11	-	11:11	-	12:11	-	-	15:11	-	-	-	17:11	-	18:11
Vich, PRA DAL MONECH - H. DOLOMITI	-	-	9:31	-	10:31	-	11:31	-	13:31	14:31	-	15:31	-	16:31	-	17:31	-
Vich, PRÉ DE SOT - OSTERIA DA CARPANO	8:13	9:13	9:32	10:13	10:32	11:13	11:32	12:13	13:32	14:32	15:13	15:32	-	16:32	17:13	17:32	18:13
Vich, COTURA - H. AI PINI	8:14	9:14	9:34	10:14	10:34	11:14	11:34	12:14	13:34	14:34	15:14	15:34	-	16:34	17:14	17:34	18:14
Vich, FORMIÉ - INCROCIO STRADA REZIA	-	-	-	10:18	-	-	-	12:18	-	-	15:18	-	-	-	17:18	-	-
Vich, CIARNADOI - H. CIARNADOI	-	-	-	10:20	-	-	-	12:20	-	-	15:20	-	-	-	17:20	-	-
VALONGIA → TAMION	-	-	-	10:22	-	-	-	12:22	-	-	15:22	-	-	-	17:22	-	-
TAMION	-	-	-	10:30	-	-	-	12:30	-	-	15:30	-	-	-	17:30	-	-
VALONGIA → VICH	-	-	-	10:32	-	-	-	12:32	-	-	15:32	-	-	-	17:32	-	-
Vich, CIARNADOI - H. BELVEDERE	-	-	-	10:34	-	-	-	12:34	-	-	15:34	-	-	-	17:34	-	-
Vich, PIAZ G.B. MASSAR - CATINACCIO LIFTS	8:18	9:20	9:40	10:35	10:40	11:20	11:40	12:35	13:40	14:40	15:35	15:40	16:20	16:40	17:35	17:40	18:20
Vich, PANTL - H. CARPE DIEM	-	9:21	-	10:36	-	11:21	-	12:36	-	-	15:36	-	16:21	-	17:36	-	18:21
Vich, PANTL - H. DOLASILLA	-	-	9:41	-	10:41	-	11:41	-	13:41	14:41	-	15:41	-	16:41	-	17:41	-
Poza, FASSA COOP → POZA	-	9:22	-	10:37	-	11:22	-	12:37	-	-	15:37	-	16:22	-	17:37	-	18:22
Vich, SEMAL - H. CRISTALLO	-	-	9:42	-	10:42	-	11:42	-	13:42	14:42	-	15:42	-	16:42	-	17:42	-
Vich, COTURA - PICCOLO HOTEL	-	-	9:43	-	10:43	-	11:43	-	13:43	14:43	-	15:43	-	16:43	-	17:43	-
Vich, PRÉ DE SOT - H. OLYMPIC	-	-	9:44	-	10:44	-	11:44	-	13:44	14:44	-	15:44	-	16:44	-	17:44	-
Vich, PRA DEL MONECH - H. SAN GIOVANNI	-	9:24	9:46	10:39	10:46	11:24	11:46	12:39	13:46	14:46	15:39	15:46	16:24	16:46	17:39	17:46	18:24
Poza, PUCIA - H. ARNIKA	-	-	9:49	10:41	10:49	-	11:49	12:41	13:49	14:49	15:41	15:49	-	16:49	17:41	17:49	-
Poza, PRA - H. GRAN BAITA	-	9:26	-	-	-	11:26	-	-	-	-	-	-	16:26	-	-	-	18:26
Poza, BAGNES - TERME	-	-	9:54	-	10:54	-	11:54	-	13:54	14:54	-	15:54	-	16:54	-	17:54	-
Poza, VAC → PERA	-	9:28	9:57	10:42	10:57	11:28	11:57	12:42	13:57	14:57	15:42	15:57	16:28	16:57	17:42	17:57	18:28
Pera, MOLIN DE PEZOL	-	9:29	9:59	10:43	10:59	11:29	11:59	12:43	13:59	14:59	15:43	15:59	16:29	16:59	17:43	17:59	18:29
Pera, PRA DE LA REGOLA - VAJOLET LIFTS	-	9:30	10:00	10:45	11:00	11:30	12:00	12:45	14:00	15:00	15:45	16:00	16:30	17:00	17:45	18:00	18:30
RONCH → MUNCION	-	9:34	-	-	-	11:34	-	-	-	-	-	-	16:34	-	-	-	18:34
MUNCION	-	9:35	-	-	-	11:35	-	-	-	-	-	-	16:35	-	-	-	18:35
RONCH → PERA	-	9:38	-	-	-	11:38	-	-	-	-	-	-	16:38	-	-	-	18:38
Pera, PERA DE SORA - H. EL PASTER	-	9:40	-	-	-	11:40	-	-	-	-	-	-	16:40	-	-	-	18:40
Pera, SAS DE SALIN - H. RIZZI	-	9:42	10:01	10:46	11:01	11:42	12:01	12:46	14:01	15:01	15:46	16:01	16:42	17:01	17:46	18:01	18:42
Poza, VAC → POZA	-	9:43	10:03	10:48	11:03	11:43	12:03	12:48	14:03	15:03	15:48	16:03	16:43	17:03	17:48	18:03	18:43
Poza, PIAZA DE COMUN	-	9:45	10:05	10:50	11:05	11:45	12:05	12:50	14:05	15:05	15:50	16:05	16:45	17:05	17:50	18:05	18:45
Poza, DASCÉ - H. EL GEIGER	-	9:46	10:07	10:52	11:07	11:46	12:07	12:52	14:07	15:07	15:52	16:07	16:46	17:07	17:52	18:07	18:46
Poza, ALOCH	-	9:47	10:08	10:53	11:08	11:47	12:08	12:53	14:08	15:08	15:53	16:08	16:47	17:08	17:53	18:08	18:47
Poza, PONT DE FAVÉ - BUFFAURE LIFTS → VIDOR	-	9:48	10:09	10:54	11:09	11:48	12:09	12:54	14:09	15:09	15:54	16:09	16:48	17:09	17:54	18:09	18:48
Poza, VIDOR	-	9:54	10:15	11:00	11:15	11:54	12:15	13:00	14:15	15:15	16:00	16:15	16:54	17:15	18:00	18:15	18:54

• 30.06. - 07.09.2024

## POZZA - PERA - VIGO | LINEA EXPRESS / FAST LINE / SCHNELLE LINIE | 30.06. - 07.09.2024

Poza, VIDOR START	10:30	11:30	13:30	14:30	16:30	17:30
Poza, PONT DE FAVÉ - BUFFAURE LIFTS → POZA	10:33	11:33	13:33	14:33	16:33	17:33
Poza, COL DE ZECOL - BAR AL PONTE	10:37	11:37	13:37	14:37	16:37	17:37
Pera, PRA DE LA REGOLA - VAJOLET LIFTS	10:43	11:43	13:43	14:43	16:43	17:43
Vich, PIAZ G.B. MASSAR - CATINACCIO LIFTS	11:03	12:03	14:03	15:03	17:03	18:03
Poza, PIAZA DE COMUN	11:10	12:10	14:10	15:10	17:10	18:10
Poza, PONT DE FAVÉ - BUFFAURE LIFTS → VIDOR	11:15	12:15	14:15	15:15	17:15	18:15
Poza, VIDOR	11:21	12:21	14:21	15:21	17:21	18:21

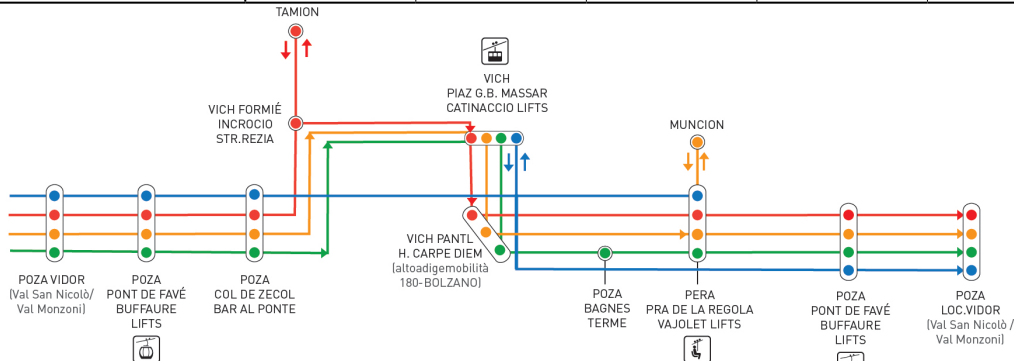

### PREZZI PRICES:

giornaliero / daily ticket / Tageskarte € 4

Prezzo ONLINE con Val di Fassa Guest Card su [ctago.it](http://ctago.it) / ONLINE price with Val di Fassa Guest Card on [ctago.it](http://ctago.it) / ONLINE-Preis mit Val di Fassa Guest Card auf [ctago.it](http://ctago.it) € 2

settimanale / weekly ticket / Wochenkarte € 20

Prezzo ONLINE con Val di Fassa Guest Card su [ctago.it](http://ctago.it) / ONLINE price with Val di Fassa Guest Card on [ctago.it](http://ctago.it) / ONLINE-Preis mit Val di Fassa Guest Card auf [ctago.it](http://ctago.it) € 10

stagionale / seasonal ticket / Saisonkarte € 50

Bambini fino a 6 anni / children up to 6 years old / Kinder bis zu 6 Jahren gratis for free

Cani (con guinzaglio e museruola) / Dogs (only with muzzle and leash) / Hunde (mit Leine und Mautkorb) € 2



DOLOMITES

TRENINO / TRACKLESS TRAIN / BUMMELZUG  
VAL SAN NICOLÒ  
ESTATE / SUMMER / SOMMER 2024

fassa.com

**POZZA DI FASSA – VAL SAN NICOLÒ**  
Piazza de Comun – Baita Ciampié



15.06 – 22.09

**ORARIO / TIMETABLE / FAHRPLAN:**

Andata / Outbound / Hinfahrt: 08.45 / 09.30 / 10.30 / 11.30 / 12.30\* / 14.30 / 15.30 / 16.30

Ritorno / Return / Rückfahrt: 10.00 / 11.00 / 12.00 / 15.00 / 16.00 / 17.00

\*Solo / only / nur 07.07 – 31.08

**PREZZI / FARES / PREISE:**

Corsa singola / one way / Einzelfahrt: € 8,50

con / with / mit Val di Fassa Guest Card: € 6,50

Bambini / children / Kinder (fino a 6 anni / up to 6 years / bis 6 Jahre): GRATIS 1:1

Cani / dogs / Hunde: € 2 (guinzaglio e museruola / muzzle and leash / Leine und Maulkorb)

**INFO:**

tel. +39 328 2852124

Il trenino dispone di 28 posti a sedere / the trackless train has 28 seats / der Bummelzug hat 28 Sitzplätze

PRENOTAZIONI GRUPPI / GROUPS RESERVATIONS / GRUPPENRESERVIERUNGEN (min. 10 p.): +39 335 7865464

### CAMPITELLO – VAL DURON

Strèda de Salin – Rifugio Micheluzzi

15.06 – 15.09

ORARIO / TIMETABLE / FAHRPLAN: 7.00-19.00

PREZZI / FARES / PREISE:      Corsa singola / one way / Einzelfahrt: € 10,00  
   Bambini / children / Kinder (fino a 10 anni / up to 10 years / bis 10 Jahre): € 5,00  
   Cani / dogs / Hunde: € 3/5 (a seconda della taglia / depending on the size / je nach Größe)  
   Trasporto bicicletta / bike transport / Fahrradbeförderung: €5,00 (max. 2)

-20% CON FASSA GUEST CARD / WITH FASSA GUEST CARD / MIT FASSA GUEST CARD

TAXI PRINOTH                      tel. +39 339 2796383  
TAXI VOLPE                        tel. +39 336 352881  
DOLOMITES TAXI                tel. +39 348 2980251

### ALBA DI CANAZEI – VAL CONTRIN

Parking Funivia Ciampac – Baita Locia Contrin

10.06 – 31.10

ORARIO / TIMETABLE / FAHRPLAN: 7.30-11.00 / 16.00→

PREZZI / FARES / PREISE:      Corsa singola 1-4 persone / one way 1-4 people / Einzelfahrt 1-4 Personen: € 32,00  
   Corsa singola da 5 persone / one way from 5 people / Einzelfahrt von 5 Personen: € 8,00





Prenotazione obbligatoria entro il giorno precedente. Per il ritorno telefonare al taxista.

Booking required within the day before. For the return journey, call the taxi driver.





Reservierung am Vortag erforderlich. Für die Rückfahrt rufen Sie den Taxifahrer an.

TAXI IORI                            tel. +39 336 808404 / +39 337 458942  
WOLF'S WAGEN                tel. +39 347 2391991





**BELVEDERE – PASSO PORDOI**

		APERTURA OPENING ÖFFNUNGSDATEN	ORARI SCHEDULE VON-BIS	PREZZI PRICES PREISE	
101	Canazei – Pecol (Tel. +39 0462 608811)	15/06 – 29/09	8.30 – 17.30	€ 8,00 - € 5,00J corsa singola/one way/Einzelfahrt € 14,50 - € 8,50J A/R / round-trip / H/R	 PP
102	Pecol – Col dei Rossi	15/06 – 29/09	8.30 – 17.20	€ 9,00 - € 5,50J corsa singola/one way/Einzelfahrt € 15,50 - € 9,50J A/R / round-trip / H/R	 PP
	Canazei – Pecol – Col dei Rossi	15/06 – 29/09	8.30 – 17.20	€14,50 - €9,00J corsa singola/one way/Einzelfahrt € 26,00 - € 15,50J A/R / round-trip / H/R	 PP
103	Sass Pordoi (Tel. +39 0462 601130)	17/05 – 15/10 16/10 – 03/11	9.00 – 17.00 9.00 – 16.30	€15,50 - €9,50J corsa singola/one way/Einzelfahrt € 28,00 - € 16,50J A/R / round-trip / H/R	 PP
126	Fodom	15/06 – 22/09	9.00 – 17.30	€ 13,00 andata / outbound / Hinfahrt € 10,00 ritorno / return / Rückfahrt € 17,50 A/R / round-trip / H/R	 PP
105	Pian Frataces – Gherdecia	29/06 – 15/09	9.00 – 17.00	€ 9,00 - € 5,50J corsa singola/one way/Einzelfahrt € 16,00 - € 9,50J A/R / round-trip / H/R	 PP
	Giornaliero Day card / Tageskarte	Col Rodella – Belvedere – Sass Pordoi		€ 43,00 - € 26,00J	

**ALBA – BELVEDERE / ALBA – CIAMPAC**

		APERTURA OPENING ÖFFNUNGSDATEN	ORARI SCHEDULE VON-BIS	PREZZI PRICES PREISE	
130	Alba – Col dei Rossi (Tel. +39 0462 608857)	08/06 – 06/10	8.30 – 17.20	€ 14,50 - € 9,00J corsa singola/one way/Einzelfahrt € 26,00 - € 15,50J A/R / round-trip / H/R	 PP
131	Alba – Ciampac (Tel. +39 0462 608856)	15/06 – 15/09	8.30 – 17.30	€ 14,00 - € 8,50J corsa singola/one way/Einzelfahrt € 23,00 - € 14,00J A/R / round-trip / H/R	 PP
136	Roseal – Giumela	15/06 – 15/09	8.30 – 12.30 14.00 – 17.00	€ 4,00 - € 2,50J corsa singola/one way/Einzelfahrt € 7,00 - € 4,00J A/R / round-trip / H/R	 PP
	Alba – Ciampac + Roseal – Giumela	15/06 – 15/09	8.30 – 12.30 14.00 – 17.00	€ 15,00 - € 9,00J corsa singola/one way/Einzelfahrt € 24,00 - € 14,50J A/R / round-trip / H/R	 PP
	Alba - Pozza	Solo andata / one way / Einzelfahrt		€ 25,00 - € 17,50J	

**CAMPITELLO – COL RODELLA – SASSOLUNGO**

		APERTURA OPENING ÖFFNUNGSDATEN	ORARI SCHEDULE VON-BIS	PREZZI PRICES PREISE	
141	Campitello – Col Rodella (Tel. +39 0462 608878)	08/06 – 06/10	8.30 – 17.30	€ 14,50 - € 9,00J corsa singola/one way/Einzelfahrt € 26,00 - € 15,50J A/R / round-trip / H/R	 PP
155	Pradel – Salei	29/06 – 15/09	9.00 – 17.00	€ 9,50 - € 5,50J corsa singola/one way/Einzelfahrt € 16,50 - € 10,00J A/R / round-trip / H/R	 PP
152	Rodella – Des Alpes	29/06 – 15/09	9.00 – 17.20	€ 4,00 - € 2,50J corsa singola/one way/Einzelfahrt € 7,00 - € 4,00J A/R / round-trip / H/R	 PP
	Pradel – Salei + Rodella – Des Alpes	29/06 – 15/09	9.00 – 17.00	€ 11,50 - € 7,00J corsa singola/one way/Einzelfahrt € 20,00 - € 12,00J A/R / round-trip / H/R	 PP
	Forcella Sassolungo (Tel. +39 0471 773102)	20/06 – 10/10	8.15 – 17.00	€ 23,00 - € 16,00J andata / outbound / Hinfahrt € 18,00 - € 12,50J ritorno / return / Rückfahrt € 30,00 - € 21,00J A/R / round-trip / H/R	 PP Cani/dogs/Hunde: €5

**POZZA – BUFFAURE**

		APERTURA OPENING ÖFFNUNGSDATEN	ORARI SCHEDULE VON-BIS	PREZZI PRICES PREISE	
201	Pozza – Buffaure (Tel. 0462 764085)	19/06 – 22/09 28/09 – 29/09	8.30 – 17.50 8.30-12.30/14-17.50	€ 13,50 - € 9,50J andata / outbound / Hinfahrt € 11,50 - € 8,00J ritorno / return / Rückfahrt € 22,00 - € 15,50J A/R / round-trip / H/R	<b>PP</b>
206	Buffaure – Col de Valvacin	19/06 – 22/09	8.30 – 12.15 14.00 – 17.30	€ 7,50 - € 5,00J andata / outbound / Hinfahrt € 6,50 - € 4,00J ritorno / return / Rückfahrt € 10,50 - € 7,00J A/R / round-trip / H/R	<b>PP</b>
	Pozza – Buffaure – Col de Valvacin	19/06 – 22/09	8.30 – 12.15 14.00 – 17.30	€ 18,00 - € 12,50J andata / outbound / Hinfahrt € 15,00 - € 10,50J ritorno / return / Rückfahrt € 25,00 - € 17,50J A/R / round-trip / H/R	
	Hike & Bike		Pozza – Alba +	€ 39,00 - € 32,00J € 18,00 con / with / mit Panorama Pass	

**VIGO DI FASSA – CATINACCIO**

		APERTURA OPENING ÖFFNUNGSDATEN	ORARI SCHEDULE VON-BIS	PREZZI PRICES PREISE	
211	Vigo - Ciampedie (Tel. 0462 763242)	01/06 – 30/06 01/07 – 01/09 02/09 – 15/09 16/09 – 06/10	8-13/14-18 8.00 – 18.30 8.00 – 18.00 8.30-13/14-18	€ 14,00 - € 10J corsa singola/one way/Einzelfahrt € 26,00 - € 18,00J A/R / round-trip / H/R	<b>PP</b>
217	Vajolet 1 ↑	15/06 – 30/06 01/07 – 01/09 02/09 – 15/09	8.30-12.15/14-17.20 8.30-12.15/14-17.45 8.30-12.15/14-17.20	€ 7,00 - € 7,00J corsa singola/one way/Einzelfahrt € 10,00 - € 10,00J A/R / round-trip / H/R	<b>PP</b>
217	Vajolet 1 ↓	15/06 – 30/06 01/07 – 01/09 02/09 – 15/09	8.30-12.45/14-18 8.30-12.45/14-18.15 8.30-12.45/14-18		
218	Vajolet 2	15/06 – 30/06 01/07 – 01/09 02/09 – 15/09	8.30-12.30/14-17.45 8.30-12.30/14-18 8.30-12.30/14-17.45	€ 7,00 - € 7,00J corsa singola/one way/Einzelfahrt € 10,00 - € 10,00J A/R / round-trip / H/R	<b>PP</b>
	Vajolet 1 + 2	15/06 – 30/06 01/07 – 01/09 02/09 – 15/09	8.30-12.15/14-17.20 8.30-12.15/14-17.45 8.30-12.15/14-17.20	€ 11,50 - € 8J corsa singola/one way/Einzelfahrt € 17,00 - € 12,00J A/R / round-trip / H/R	<b>PP</b>
215	Pian Pecei – Ciampedie ↑	15/06 – 30/06 01/07 – 14/07 15/07 – 01/09 02/09 – 15/09	8.30-12.45/14-17.45 8.30-12.45/14-18.15 8.30 – 17.50 8.30-12.45/14-17.45	€ 7,00 - € 7,00J corsa singola/one way/Einzelfahrt € 10,00 - € 10,00J A/R / round-trip / H/R	<b>PP</b>
215	Ciampedie – Pian Pecei ↓	15/06 – 30/06 01/07 – 14/07 15/07 – 01/09 02/09 – 15/09	8.30-12.15/14-17.30 8.30-12.15/14-17.50 8.30 – 17.50 8.30-12.15/14-17.30		
223	Pian Pecei – Pra Martin	29/06 – 01/09	8.30 – 12.30 14.00 – 17.45	€ 7,00 - € 7,00J corsa singola/one way/Einzelfahrt € 10,00 - € 10,00J A/R / round-trip / H/R	<b>PP</b>
	Pera – Ciampedie Pera – Pra Martin	15/06 – 30/06 01/07 – 01/09 02/09 – 15/09	8.30-12.15/14-17.20 8.30-12.15/14-17.45 8.30-12.15/14-17.20	€ 14,00 - € 10J corsa singola/one way/Einzelfahrt € 26,00 - € 18,00J A/R / round-trip / H/R	<b>PP</b>
	Giornaliero Day card / Tageskarte			€ 35,00 - € 25,00J	

**CAREZZA**

		APERTURA OPENING ÖFFNUNGSDATEN	ORARI SCHEDULE VON-BIS	PREZZI PRICES PREISE	
411	Paolina (Tel. +39 0471 612112)	30/05 – 12/07 13/07 – 25/08 26/08 – 13/10	8.30 – 17.30 8.00 – 18.00 8.30 – 17.30	€ 17,00 - € 11J corsa singola/one way/Einzelfahrt € 24,00 - € 16,00J A/R / round-trip / H/R	<b>PP</b>
401	Nova Levante – Laurin I (Tel. +39 0471 614139)	18/05 – 12/07 13/07 – 25/08 26/08 – 13/10 14/10 – 03/11	8.15 – 17.45 8.00 – 18.15 8.15 – 17.45 8.45 – 17.15	€ 17,00 - € 11J corsa singola/one way/Einzelfahrt € 24,00 - € 16,00J A/R / round-trip / H/R	<b>PP</b>
402 403	König Laurin 1 & 2	30/05 – 12/07 13/07 – 25/08 26/08 – 13/10 14/10 – 03/11	8.30 – 17.30 8.00 – 18.00 8.30 – 17.30 9.00 – 17.00	€ 17,00 - € 11J corsa singola/one way/Einzelfahrt € 24,00 - € 16,00J A/R / round-trip / H/R KL1/KL2: €12 - €8,00J singola/one way/Einzelfahrt KL1/KL2: € 17 - € 11J A/R / round-trip / H/R	<b>PP</b> König Laurin 2 NO BIKE
404	Tschein	30/05 – 12/07 13/07 – 25/08 26/08 – 13/10	9.30 – 17.30 9.00 – 18.00 9.30 – 17.30	€ 17,00 - € 11J corsa singola/one way/Einzelfahrt € 24,00 - € 16,00J A/R / round-trip / H/R	<b>PP</b>

400	Tires	18/05 – 12/07 13/07 – 25/08 26/08 – 13/10 14/10 – 03/11	8.15 – 17.45 8.00 – 18.15 8.15 – 17.45 8.45 – 17.15	€ 17,00 - € 11,00J corsa singola/one way/Einzelfahrt € 24,00 - € 16,00J A/R / round-trip / H/R	
	Giornaliero ROSENGARTENPASS Day card/Tageskarte			€ 36,00 - € 25,00J	
	Oneway Rosengarten			€ 24,00 - € 16,00J	

### MOENA – ALPE LUSIA – BELLAMONTE

		APERTURA OPENING ÖFFNUNGSDATEN	ORARI SCHEDULE VON-BIS	PREZZI PRICES PREISE	
201	Ronchi – Valbona (Tel. +39 0462 573207)	15/06 – 22/09	8.30 – 12.45 14.00 – 17.15	€ 11,00 - € 6,50J corsa singola/one way/Einzelfahrt € 16,50 - € 9,50J A/R / round-trip / H/R	
202	Valbona – Le Cune	15/06 – 22/09	8.30 – 12.45 14.00 – 17.15	€ 11,00 - € 6,50J corsa singola/one way/Einzelfahrt € 16,50 - € 9,50J A/R / round-trip / H/R	
	Ronchi – Valbona – Le Cune	15/06 – 22/09	8.30 – 12.45 14.00 – 17.15	€ 19,00 - € 10,00J corsa singola/one way/Einzelfahrt € 23,00 - € 14,00J A/R / round-trip / H/R	
205	Campo – Le Cune	13/07 – 01/09	9.00 – 12.30 14.00 – 17.00	€ 6,50 - € 5,50J corsa singola/one way/Einzelfahrt € 11,00 - € 9,00J A/R / round-trip / H/R	
	Giro d'Ali	Ronchi – Valbona – Le Cune – Campo		€ 28,00 - € 17,00J	
44 45	Castelir – Le Fassane – La Morea (Tel. 0462 576234)	15/06 – 03/08 04/08 – 25/08 26/08 – 22/09	9-12.45/14-17.15 9.00 – 17.15 9-12.45/14-17.15	€ 18,00 - € 11,00J corsa singola/one way/Einzelfahrt € 22,00 - € 13,00J A/R / round-trip / H/R	
	Alpe Lusia All- Inclusive	Ronchi – Valbona – Le Cune – Campo Castelir – Le Fassane – La Morea		€ 33,00 - € 20,00J	





### PASSO SAN PELLEGRINO – FALCADE

		APERTURA OPENING ÖFFNUNGSDATEN	ORARI SCHEDULE VON-BIS	PREZZI PRICES PREISE	
309	Col Margherita (Tel. +39 0462 573676)	29/06 – 15/09	9.00 – 17.30	€ 12,00 - € 8,00J andata / outbound / Hinfahrt € 10,00 - € 8,00J ritorno / return / Rückfahrt € 18,00 - € 13,00J A/R / round-trip / H/R	
303	Costabella	22/06 – 15/09	8.30 – 12.50 14.00 – 17.30	€ 10,00 - € 7,00J corsa singola/one way/Einzelfahrt € 15,00 - € 10,50J A/R / round-trip / H/R	
408	FalCADE – Le Buse (Tel. +39 0437 507044)	06/07 – 08/09	9.00 – 12.50 14.00 – 17.30	€ 10,00 - € 7,00J andata / outbound / Hinfahrt € 8,00 - € 7,00J ritorno / return / Rückfahrt € 14,00 - € 10,00J A/R / round-trip / H/R	
407	Le Buse – Laresei	06/07 – 08/09	9.00 – 13.00 14.10 – 17.30	€ 8,00 - € 5,00J andata / outbound / Hinfahrt € 6,00 - € 5,00J ritorno / return / Rückfahrt € 10,00 - € 7,00J A/R / round-trip / H/R	
	FalCADE – Le Buse – Laresei	06/07 – 08/09	9.00 – 12.50 14.10 – 17.30	€ 11,00 - € 9,00J corsa singola/one way/Einzelfahrt € 20,00 - € 14,00J A/R / round-trip / H/R	

### MARMOLADA

		APERTURA OPENING ÖFFNUNGSDATEN	ORARI SCHEDULE VON-BIS	PREZZI PRICES PREISE	
	Malga Ciapela – Serauta (Tel. +39 0437 522984)	29/06 – 15/09	9.00 – 16.30	€ 25,00 - € 15,00J ritorno / return / Rückfahrt € 32,00 - € 18,00J A/R / round-trip / H/R	
	Malga Ciapela – Punta Rocca	29/06 – 15/09	9.00 – 16.30	€ 27,00 - € 16,00J ritorno / return / Rückfahrt € 38,00 - € 22,00J A/R / round-trip / H/R	
	Padon (Tel. +39 0437 722145)	22/06 – 15/09	9.15 – 16.40	€ 12,00 - € 8,50J corsa singola/one way/Einzelfahrt € 16,00 - € 11,00J A/R / return ticket / H/R	

**LEGENDA / KEY / LEGENDE:**

	Accessibile ai disabili Accessible to the disabled / Zugänglich für Behinderte
	Cani ammessi Dogs allowed / Hunde erlaubt
	Trasporto bici Bike transport / Fahrradtransport
	Panorama Pass

**NOTE**

- Gli orari sopraelencati si riferiscono al tempo massimo di apertura dell'impianto. Alcune seggiovie potrebbero funzionare ad orari parzialmente ridotti. Verificare presso ogni singolo impianto.
- Le date e gli orari di apertura e chiusura degli impianti possono essere soggetti a variazioni.
- Sconti per bambini, seniores, gruppi e disabili, dove previsti: prezzi alla cassa.
- Cani ammessi solo se dotati di museruola e guinzaglio. Per i cani saranno applicate le tariffe previste dai singoli impianti di risalita.

**NOTES**

- The timetable refers to the time-limit of every cableway. Some chairlifts might work not in accordance with the schedule and follow a reduced opening time. Please check the opening times directly at the lifts' desk.
- The lifts opening and closing dates may be subject to change.
- Reductions for children, seniores, groups and disabled people, where existing: prices at the cashier.
- Dogs must be kept on a leash and wear a muzzle. The dog ticket price is determined by the individual lift societies.

**NOTEN**

- Die Fahrpläne beziehen sich auf die vorgegebene Höchstzeit jeder Seilbahn. Einige Sessellifte könnten verkürzte Zeiten befolgen. Prüfen Sie bitte die Richtigkeit des Fahrplans verkürzte, wenn Sie an der Seilbahn ankommen.
- Die Daten sind mit Vorbehalt zu genießen und werden kontinuierlich aktualisiert.
- Ermäßigungen für Kinder, Seniores, Gruppen und Behinderten, falls vorgesehen: Preise an der Kasse.
- Hunde nur mit Maulkorb und an der Leine. Für die Hunde gelten die von den einzelnen Aufstiegsanlagen vorgesehenen Tarifbedingungen.